

Article number: 0101089  
 Description: Retaining ring A 82 DIN 471  
 Spring steel  
 Note: Fitted with ZGA pilers

## Measures

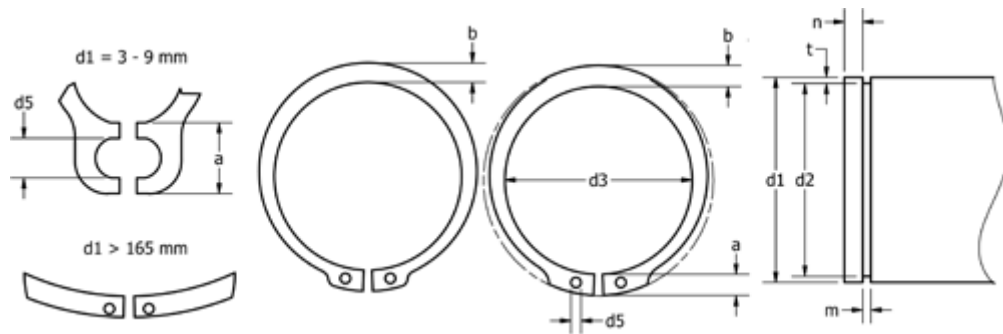

a max	= 8.7	FN kN	= 73.5	s	= 2.50
AN mm <sup>2</sup>	= 441.0	FRg kN	= 19.60	t	= 1.75
b	= 7.6	FR kN	= 128.00	tol	= -0.30
d1	= 82	g	= 3.0	tol	= -0.07
d2	= 78.5	K kN-mm	= 237.00	tol	= +0,46-1,10
d3	= 76.5	m min	= 2.65	Tong	= ZGA-3
d5 min	= 3.0	n abl x 1000	= 6.0	Weight kg/1000	= 31.200
Description	= A82	Nominal drive	= 5.3		